

Orientation: Left or Right
 (Both left and right must be used
 when using CH4 as shelving supports)

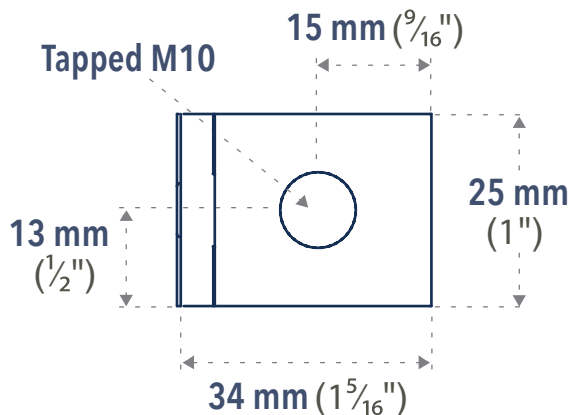
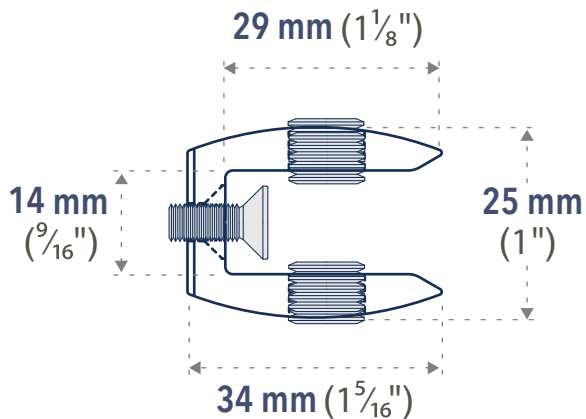

ACCESSORIES / PANEL & SHELF SUPPORTS

Part #	Screws Included	Toggles Included	Hex Key Size
404 60 CH4 at 60°	DIN551; DIN7991 M5x10	PR2	3mm
	Material	Finish	
	Aluminum Alloy	Clear Anodized *Custom colors and textures are also available - powder coat paint.	