

ELEVATION

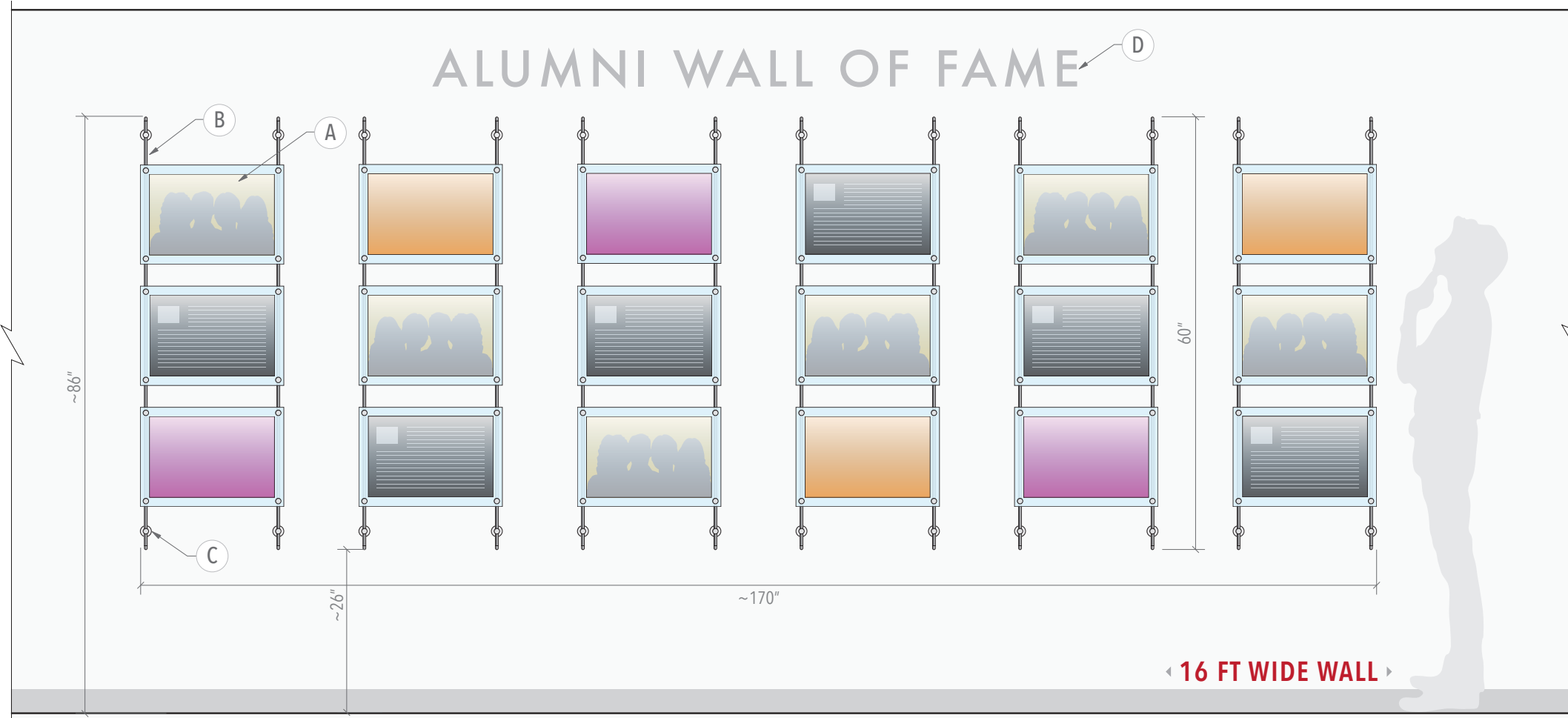

NOVADISPLAY
INNOVATIVE DISPLAY SOLUTIONS

Nova Display Systems, Inc.
875 Wilson St., Ste. A-B
Eugene, OR 97402
541.505.7450
541.505.9919 fax
sales@novadisplay.com
www.novadisplaysystems.com

Wall Display Concept

ID: DC2607

Title: Recognition Wall Display

Description: Display incorporates acrylic sandwich frames for 11" x 17" format photo or info/poster inserts mounted to wall with 10mm rod system.

Display Size:
68"H x 170"W

Wall Size Requirements:
16 FT (192 IN) Wide

Display Hardware:
Rod Display System

Classification:
Recognition wall displays
Recognition wall display ideas
Wall of fame
Wall of honor
Wall of distinction
Wall of achievement
Wall of success
Award wall display

Note: This drawing is the property of Nova Display Systems and is not to be reproduced or copied in whole or in part. It is only to be used for the project and site specifically identified herein and is not to be used on any other projects, or for the purpose of manufacturing and reproduction. It is to be returned upon request.

Sheet:

DETAILS:

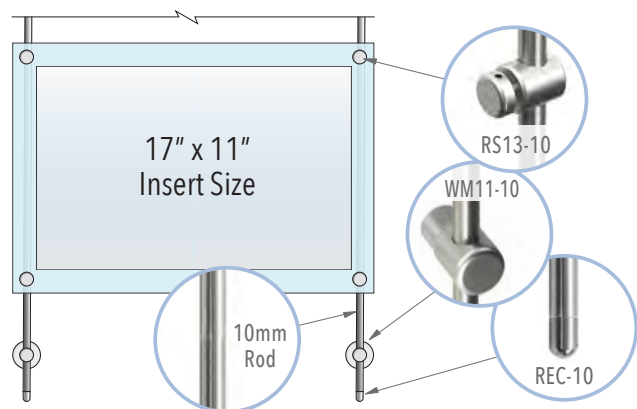









NOTES:

- A** Non-Glare Acrylic Frame Set for changeable info/photo inserts. Use with 17" x 11" (1ea) or 8.5" x 11" (2ea) printed inserts (not included).
- B** 10mm diameter vertical rod display system mounted to wall with twist-n-lock drywall anchor. Each column is supplied with two 59" long **R1500-10** rods with both threaded ends for use with **REC-10** decorative caps. *** No rod cutting to size is needed.
- C** Rods are mounted onto the wall with **WM11-10** supports. **P01** decorative support plates are optional.
- D** Dimensional Lettering: "ALUMNI WALL OF FAME" in 5" high Futura Medium Font Style – Laser Cut Acrylic Letters in 1/4" thick satin/matte black finish face and double-sided tape on the back for wall mounting.

Hardware: All fixings, components supplied in satin chrome finish. Rods are stainless steel.

COMPONENT LIST:

 WM11-10 (24 ea)	 P01 (24 ea)	 REC-10 (24 ea)	 *R1500-10 (12 ea)	 RS13-10 (72 ea)
 P75-TWL (24 ea)	 18ASP-W-1117/M4 (18 ea)	 18ASP-W-1117NG/M4 (18 ea)	 14LTR-FUTURA-MEDIUM -5IN-20BK (1 SET)	