

WALL INSTALL TEMPLATE

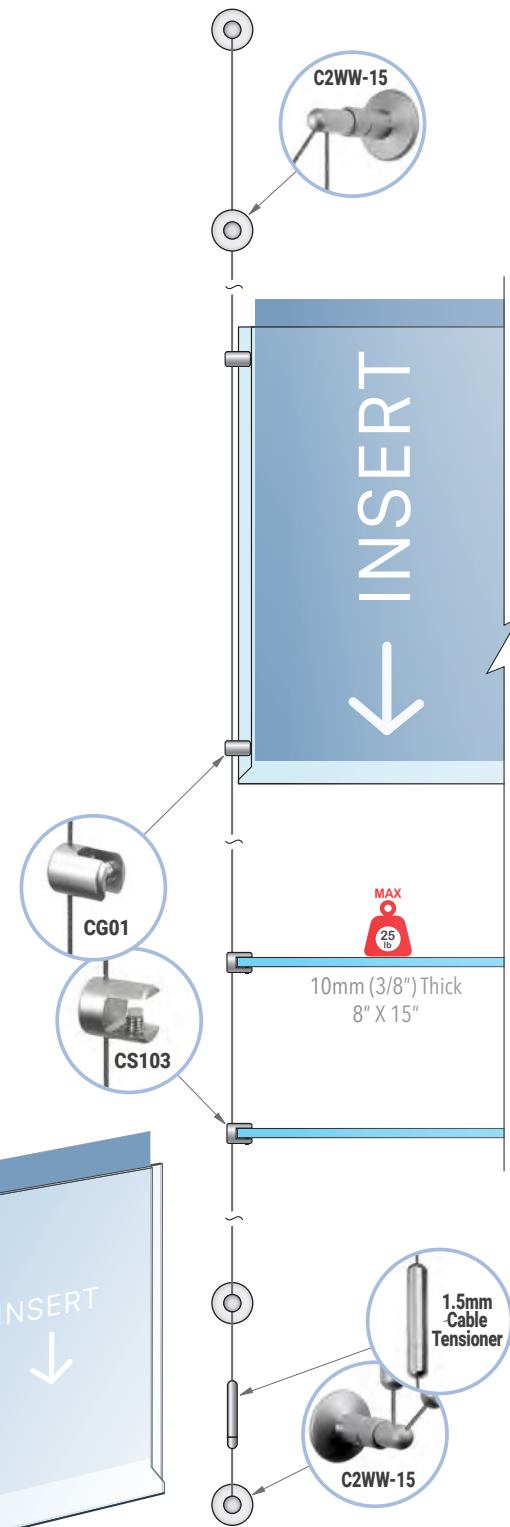

DETAILS:

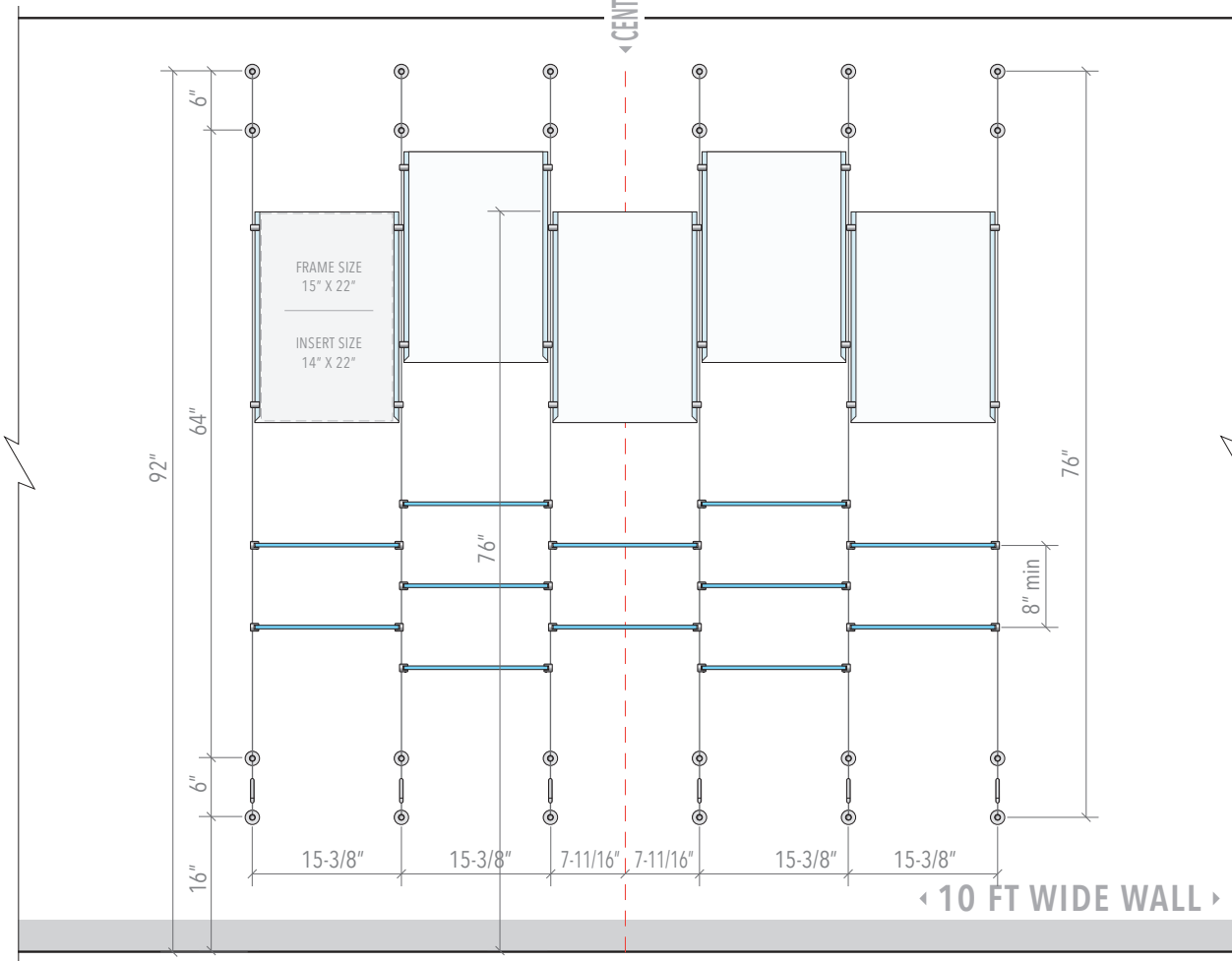
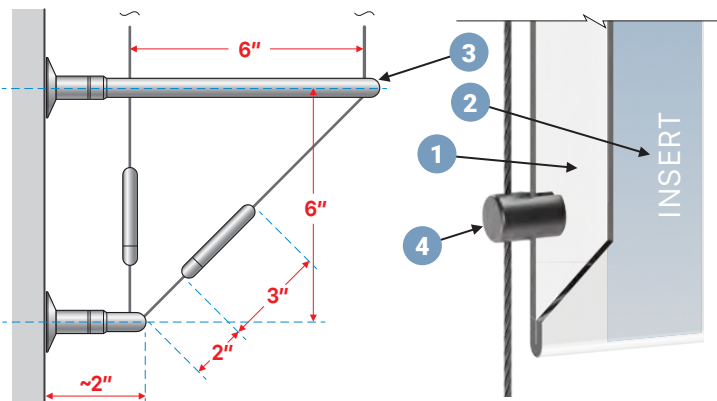

Easy Access Acrylic Frames for Info/Poster Inserts / Cable Suspended

1. Expo Style Easy Access Acrylic Frames are made of 1/8" thick clear folded acrylic with side tabs and are mounted to wall using cable display system. Frames are available in "clear" or "non-glare" acrylic finish.
2. Acrylic frames can be used with standard prints or paper posters up to 135 gsm or 1 mm (1/32") thickness.
3. C2WW-15 wall-to-wall cable sets are supplied with 3M (9'-10") long cables and can be cut shorter to fit in designated space.
4. Use CG01 supports to mount the easy access acrylic holders to vertical cables closer to wall.

Note: Non-glare (non-reflective) acrylic front cover helps to reduce the glare and provides a mild protection against harmful UV rays.

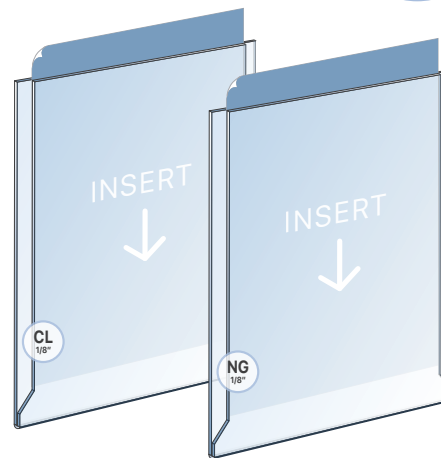

Nova Display Systems, Inc.
875 Wilson St., Ste. A-B
Eugene, OR 97402
541.505.7450
541.505.9919 fax
sales@novadisplay.com
www.novadisplaysystems.com

Wall Display Concept

ID: DC3101

Title: Product Wall Display

Display Size:
78"H x 80"W

Wall Size Requirements:
10 FT (120 IN) Wide

Wall Install Template

ID: DC3101-WT

Note: Dimensions on the drawing display hardware mounting points on the wall. These are suggested dimensions and can be slightly modified to accommodate for your own wall specifics.

Note: This drawing is the property of Nova Display Systems and is not to be reproduced or copied in whole or in part. It is only to be used for the project and site specifically identified herein and is not to be used on any other projects, or for the purpose of manufacturing and reproduction. It is to be returned upon request.

Sheet: