

INSTALLATION GUIDE

HOOK-ON ACRYLIC HOLDERS MOUNTED TO 6MM ROD SYSTEMS

WM11 & RS03 Rod Support Fixing

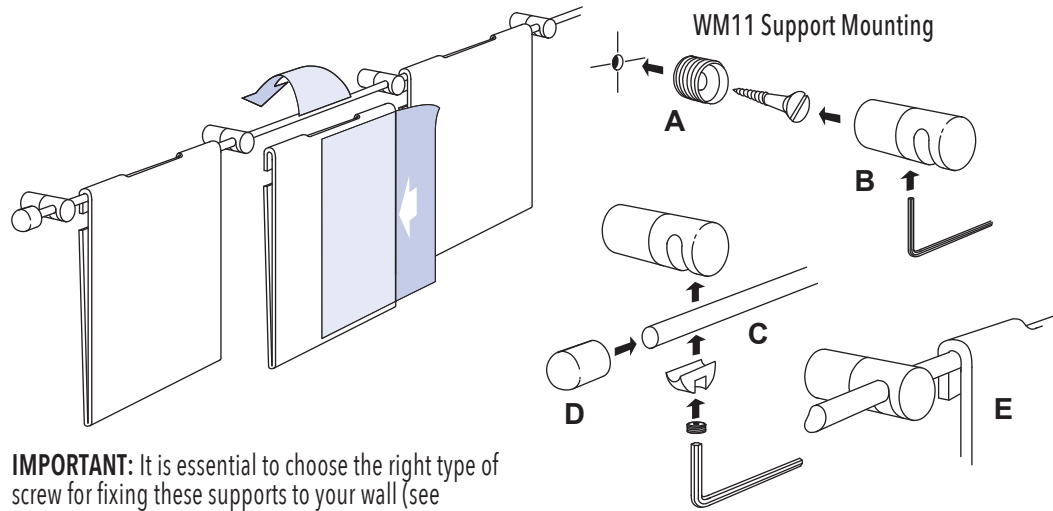

IMPORTANT: It is essential to choose the right type of screw for fixing these supports to your wall (see diagrams below).

1) Select the first point at which rod is to start. Affix the brass fitting (A), or P02 nickel support (A1) to wall using a suitable fixing depending on the wall type:

- for wood stud walls use a wood screw.
- for cavity/plaster wall use a spring toggle bolt or twist-n-lock anchors.
- for solid/concrete wall use a raw-plug and screw.

2) Using a measuring tape and a leveler; mark all fixing points as required in order to fit your acrylic pocket format, or any other hook-on acrylic accessories, and repeat procedure for all brass fittings (A-A1).

3) Affix all wall supports (B-B1) onto the brass fittings (A-A1).

4) Loosen the set screws on the wall supports (B-B1), and slide the rod (C-C1) into the open cavities at required position. Then tighten back the set screws with Allen Key provided. Rod needs to be cut to size before attaching to the wall.

5) Attach the decorative end cap (D-D1) to both ends of rod.

6) Attach your acrylic accessories (E) to the rod.

NOTE: For lightweight display components such as small and medium size acrylic frames and holders Nova Display Systems provides twist-n-lock anchors. It is at your discretion to use the anchors provided or use similar product rated for 50 to 75 lb weight limit.

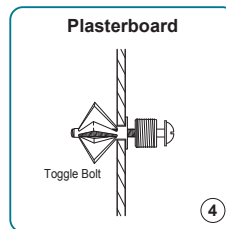
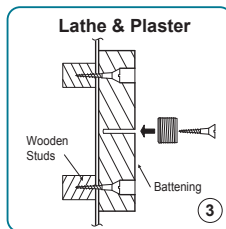
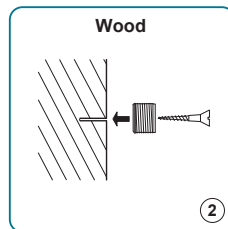
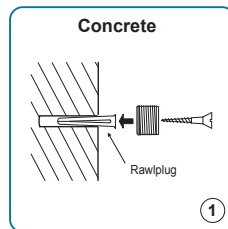
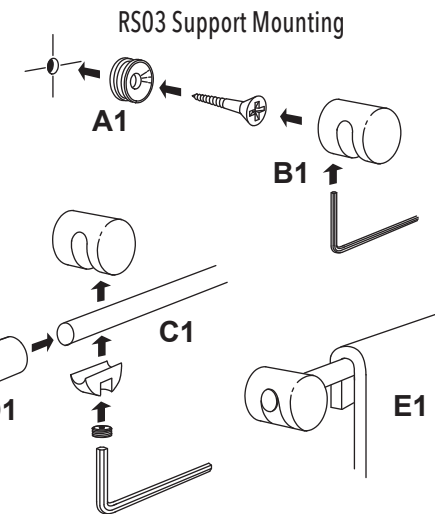

FRAMELESS ACRYLIC FRAMES MOUNTED WITH STANDOFF SYSTEMS

WM15 Standoff Support or Similar

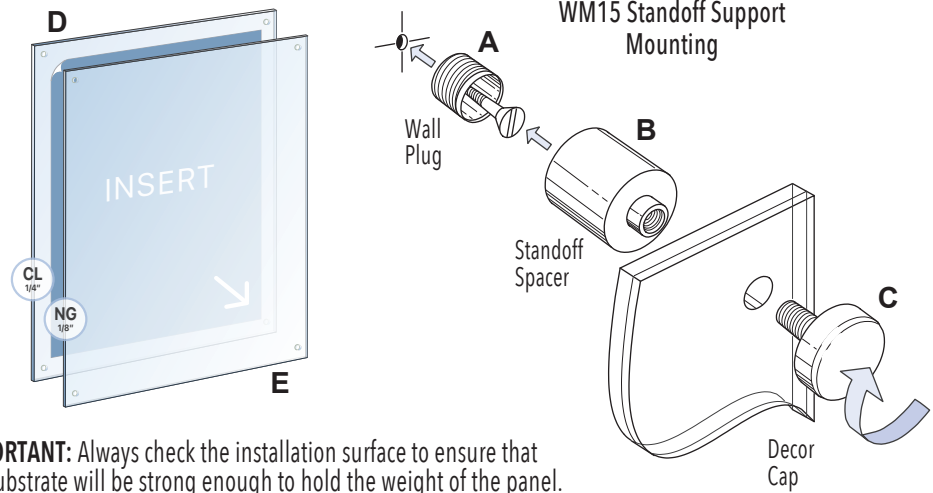

IMPORTANT: Always check the installation surface to ensure that the substrate will be strong enough to hold the weight of the panel.

1) Using a measuring tape and a leveler; locate and mark all fixing points for each four standoffs as shown in "Wall Install Template / Diagram". Affix the brass fitting (A) to wall using a suitable fixing depending on the wall type:

- for wood stud walls use a wood screw.
- for cavity/plaster wall use a spring toggle bolt or twist-n-lock anchors.
- for solid/concrete wall use a raw-plug and screw.

2) Screw standoff barrels (B) tightly onto the wall plugs / brass fittings (A), and repeat procedure for all standoff fittings at each corner of the panel.

3) Using low-tack (3M™ 9415PC Removable Repositionable) double sided adhesive tape mount each print to front face of the back panel (D). Cover the print with the non-glare front panel (E) and with the assistance of a helper attach the panel/graphic board set to standoff spacers and affix them with the front caps (C). Make sure the non-glare/matte surface of cover panel is facing the front.

4) The caps can be tightened by using a M4 Allen Wrench on the small hole located on the side of the cap. Important to make sure that all wall plugs (A) are securely tightened.

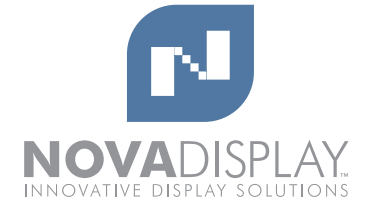
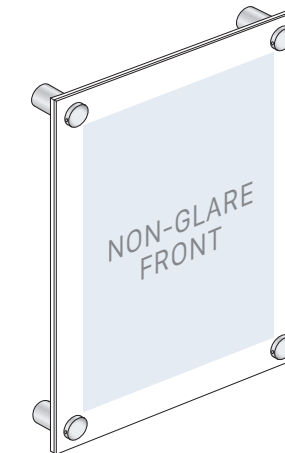
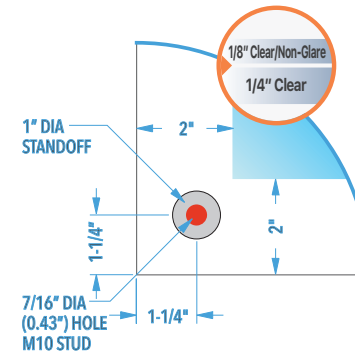

Nova Display Systems, Inc.
875 Wilson St., Ste. A-B
Eugene, OR 97402
541.505.7450
541.505.9919 fax
sales@novadisplaysystems.com
www.novadisplaysystems.com

Wall Display Concept

ID: DC2130-2139

Title: Photo Wall Display

Installation Guide

ID: DC2130-INST

NOTE: It is important to check the strength of the wall fixing(s). Nova Display Systems takes no responsibility for incorrect installation. This responsibility relies with the installer.

Note: This drawing is the property of Nova Display Systems and is not to be reproduced or copied in whole or in part. It is only to be used for the project and site specifically identified herein and is not to be used on any other projects, or for the purpose of manufacturing and reproduction. It is to be returned upon request.

Sheet:

Page: 1 of 1

Scale: n/a